

## 阅读申明

- 1.本站收集的数据手册和产品资料都来自互联网，版权归原作者所有。如读者和版权方有任何异议请及时告之，我们将妥善解决。
- 2.本站提供的中文数据手册是英文数据手册的中文翻译，其目的是协助用户阅读，该译文无法自动跟随原稿更新，同时也可能存在翻译上的不当。建议读者以英文原稿为参考以便获得更精准的信息。
- 3.本站提供的产品资料，来自厂商的技术支持或者使用者的心得体会等，其内容可能存在描述上的差异，建议读者做出适当判断。
- 4.如需与我们联系，请发邮件到marketing@iczoom.com，主题请标有“数据手册”字样。

## Read Statement

1. The datasheets and other product information on the site are all from network reference or other public materials, and the copyright belongs to the original author and original published source. If readers and copyright owners have any objections, please contact us and we will deal with it in a timely manner.
2. The Chinese datasheets provided on the website is a Chinese translation of the English datasheets. Its purpose is for reader's learning exchange only and do not involve commercial purposes. The translation cannot be automatically updated with the original manuscript, and there may also be improper translations. Readers are advised to use the English manuscript as a reference for more accurate information.
3. All product information provided on the website refer to solutions from manufacturers' technical support or users the contents may have differences in description, and readers are advised to take the original article as the standard.
4. If you have any questions, please contact us at marketing@iczoom.com and mark the subject with "Datasheets" .

# WAU8822

## 24-bit Stereo Audio Codec with Speaker Driver

*emPowerAudio™*

### Description

The WAU8822 is a low power, high quality CODEC for portable applications. In addition to precision 24-bit stereo ADCs and DACs, this device integrates a broad range of additional functions to simplify implementation of complete audio system solutions. The WAU8822 includes drivers for speaker, headphone, and differential or stereo line outputs, and integrates preamps for stereo differential microphones, significantly reducing external components.

Advanced on-chip digital signal processing includes a 5-band equalizer, a 3-D audio enhancer, a mixed-signal automatic level control for the microphone or line input through the ADC, and a digital limiter function for the playback path. Additional digital filtering options are available in the ADC path, to simplify implementation of specific application requirements such as 'wind noise reduction'. The digital interface can operate as either a master or a slave. Additionally, an internal fractional PLL is available to generate accurate audio sample rate clocks for the CODEC derived from a wide range of commonly available system clock frequencies such as 12MHz and 13MHz.

The WAU8822 operates with analog supply voltages from 2.5V to 3.6V, while the digital core can operate at 1.65V to conserve power. The loudspeaker BTL output pair and two auxiliary line outputs can operate using a 5V supply to increase output power capability, enabling the WAU8822 to drive 1 Watt into an external speaker. Internal register controls enable flexible power saving modes by powering down sub-sections of the chip under software control.

The WAU8822 is specified for operation from -40°C to +85°C, and is available with full automotive AEC-/Q100 & TS16949 qualification. It is packaged in a cost-effective, space-saving 32-lead QFN package.

### Key Features

- DAC: 94dB SNR and -84dB THD ("A" weighted)
- ADC: 90dB SNR and -80dB THD ("A" weighted)
- Integrated BTL speaker driver: 1W into 8Ω
- Integrated head-phone driver: 40mW into 16Ω
- Integrated programmable microphone amplifier
- Integrated line input and line output
- On-chip PLL
- Integrated DSP with specific functions:
  - 5-band equalizer
  - 3-D audio enhancement
  - Automatic level control
  - Audio level limiter
  - Multiple filtering options

- Standard audio interfaces: PCM and I<sup>2</sup>S
- Serial control interfaces with read/write capability
- Supports audio sample rates from 8kHz to 48kHz

### Applications

- Personal Media Players
- Smartphones
- Personal Navigation Devices
- Portable Game Players
- Camcorders
- Digital Still Cameras
- Portable TVs
- Stereo Bluetooth Headsets

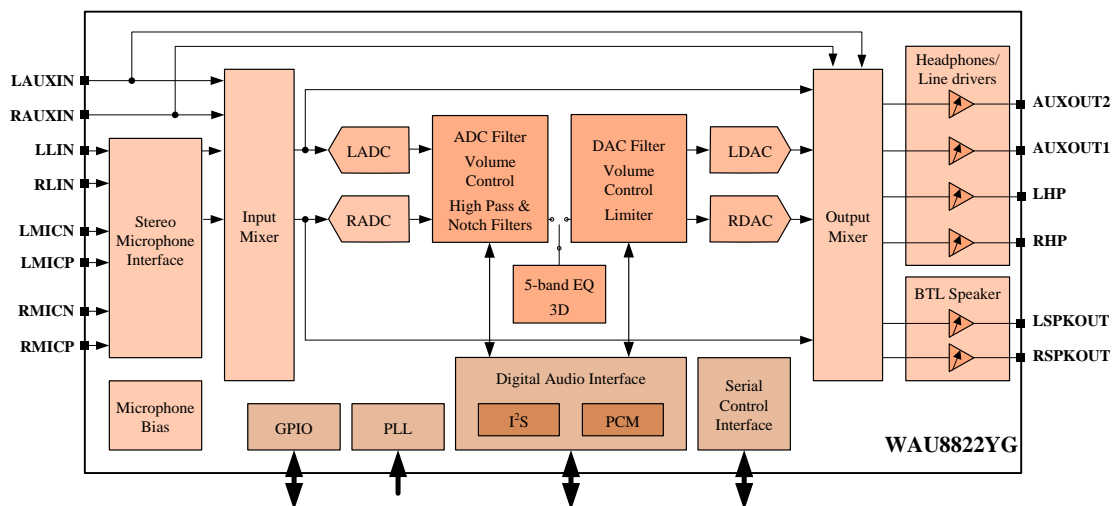

## Pinout

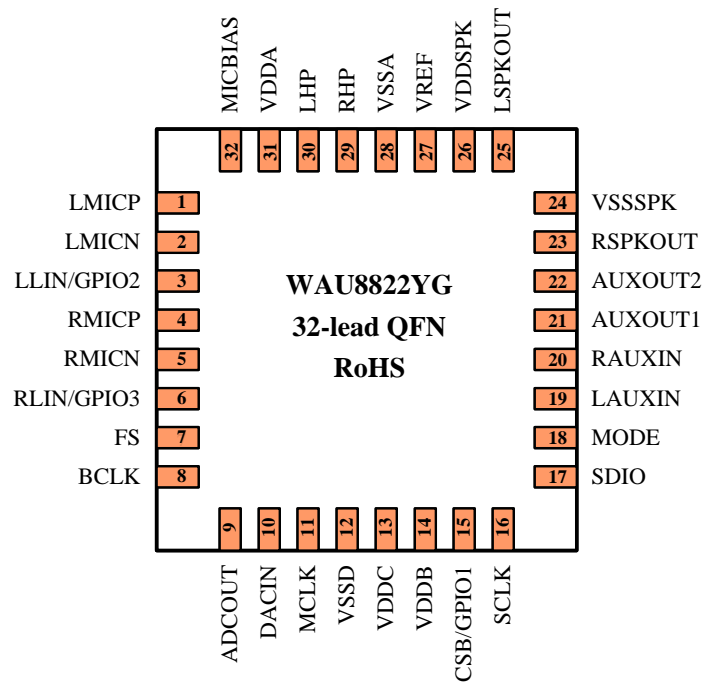

Part Number	Dimension	Package	Package Material
WAU8822YG	5 x 5 mm	32-QFN	Pb-Free

## Pin Descriptions

Pin #	Name	Type	Functionality
1	LMICP	Analog Input	Left MICP Input (common mode)
2	LMICN	Analog Input	Left MICN Input
3	LLIN/GPIO2	Analog Input / Digital I/O	Left Line Input / alternate Left MICP Input / GPIO2
4	RMICP	Analog Input	Right MICP Input (common mode)
5	RMICN	Analog Input	Right MICN Input
6	RLIN/GPIO3	Analog Input / Digital I/O	Right Line Input/ alternate Right MICP Input / Digital Output In 4-wire mode: Must be used for GPIO3
7	FS	Digital I/O	Digital Audio DAC and ADC Frame Sync
8	BCLK	Digital I/O	Digital Audio Bit Clock
9	ADCOUT	Digital Output	Digital Audio ADC Data Output
10	DACIN	Digital Input	Digital Audio DAC Data Input
11	MCLK	Digital Input	Master Clock Input
12	VSSD	Supply	Digital Ground
13	VDDC	Supply	Digital Core Supply
14	VDDB	Supply	Digital Buffer (Input/Output) Supply
15	CSB/GPIO1	Digital I/O	3-Wire MPU Chip Select or GPIO1 multifunction input/output
16	SCLK	Digital Input	3-Wire MPU Clock Input / 2-Wire MPU Clock Input
17	SDIO	Digital I/O	3-Wire MPU Data Input / 2-Wire MPU Data I/O
18	MODE	Digital Input	Control Interface Mode Selection Pin
19	LAUXIN	Analog Input	Left Auxiliary Input
20	RAUXIN	Analog Input	Right Auxiliary Input
21	AUXOUT1	Analog Output	Headphone Ground / Mono Mixed Output / Line Output
22	AUXOUT2	Analog Output	Headphone Ground / Line Output
23	RSPKOUT	Analog Output	BTL Speaker Positive Output or Right high current output
24	VSSSPK	Supply	Speaker Ground (ground pin for RSPKOUT, LSPKOUT, AUXOUT2 and AUXTOUT1 output drivers)
25	LSPKOUT	Analog Output	BTL Speaker Negative Output or Left high current output
26	VDDSPK	Supply	Speaker Supply (power supply pin for RSPKOUT, LSPKOUT, AUXOUT2 and AUXTOUT1 output drivers)
27	VREF	Reference	Decoupling for Midrail Reference Voltage
28	VSSA	Supply	Analog Ground
29	RHP	Analog Output	Headphone Positive Output / Line Output Right
30	LHP	Analog Output	Headphone Negative Output / Line Output Left
31	VDDA	Supply	Analog Power Supply
32	MICBIAS	Analog Output	Microphone Bias

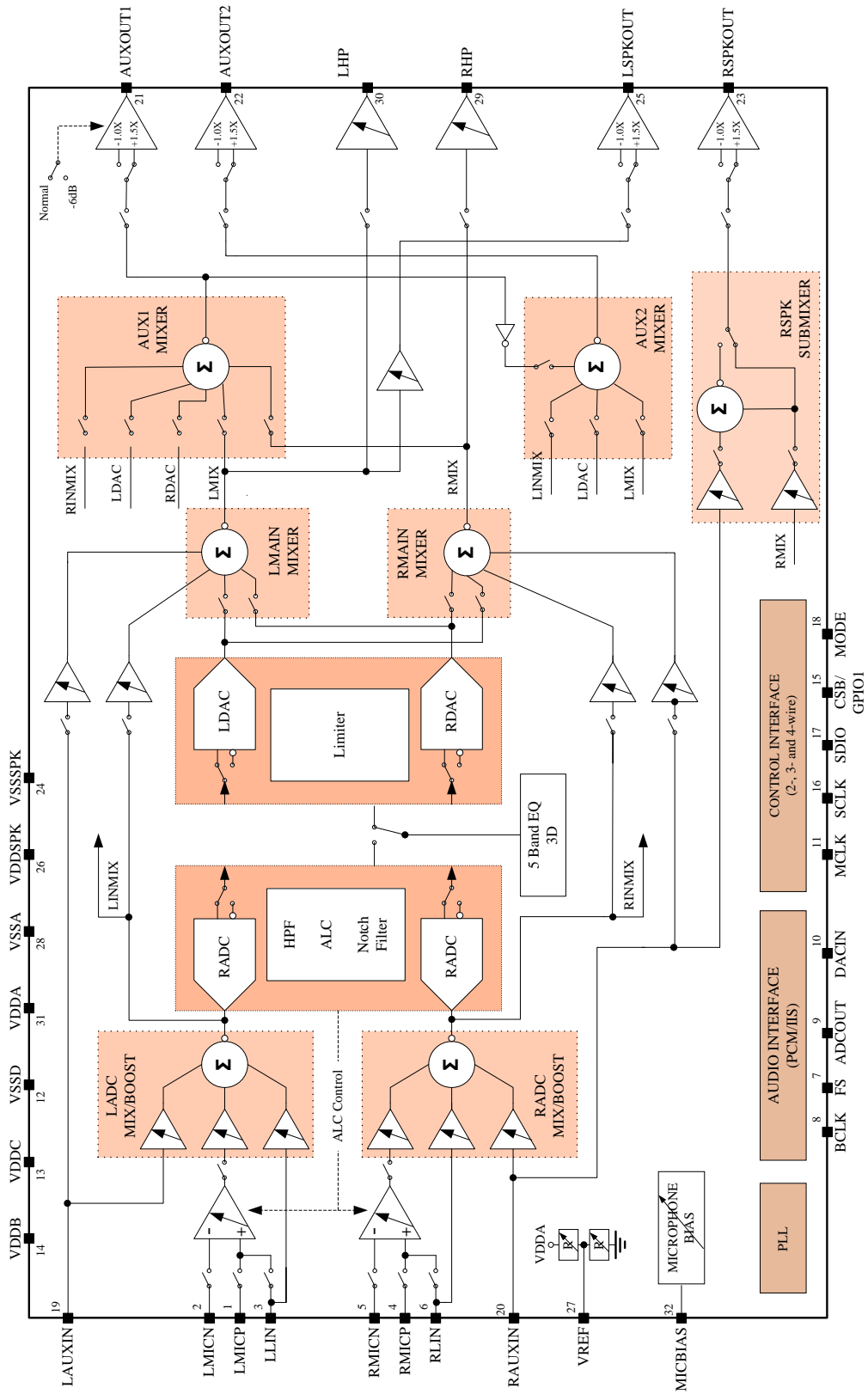

Figure 1: WU8822 Block Diagram

## Electrical Characteristics

Conditions: VDDC = 1.8V, VDDA = VDDB = VCCSPK = 3.3V, MCLK = 12.88MHz, T<sub>A</sub> = +25°C, 1kHz signal, fs = 48kHz, 24-bit audio data, 64X oversampling rate, unless otherwise stated.

Parameter	Symbol	Comments/Conditions	Min	Typ	Max	Units
<b>Analog to Digital Converter (ADC)</b>						
Full scale input signal <sup>1</sup>	V <sub>INFS</sub>	PGABST = 0dB PGAGAIN = 0dB		1.0 0		V <sub>rms</sub> dBV
Signal-to-noise ratio	SNR	Gain = 0dB, A-weighted	tbd	90		dB
Total harmonic distortion <sup>2</sup>	THD+N	Input = -3dB FS input		-80	tbd	dB
Channel separation		1kHz input signal		<b>103</b>		dB
<b>Digital to Analog Converter (DAC) driving RHP / LHP with 10kΩ / 50pF load</b>						
Full-scale output		Output boost disabled PGA gains = 0dB AUX1BST = 1 AUX2BST = 1	VDDA / 3.3			V <sub>rms</sub>  V <sub>rms</sub>
		Output boost enabled PGA gains = 0dB AUX1BST = 0 AUX2BST = 0	1.5 * (VDDA / 3.3)			
Signal-to-noise ratio	SNR	A-weighted	88	94		dB
Total harmonic distortion <sup>2</sup>	THD+N	R <sub>L</sub> = 10kΩ; full-scale signal		-84	tbd	dB
Channel separation		1kHz input signal		<b>96</b>		dB
<b>Output Mixers</b>						
Maximum PGA gain into mixer				+6		dB
Minimum PGA gain into mixer				-15		dB
PGA gain step into mixer		Guaranteed monotonic		3		dB
<b>Speaker Output (RSPKOUT / LSPKOUT with 8Ω bridge-tied-load)</b>						
Full scale output <sup>4</sup>		SPKBST = 1	VCCSPK / 3.3			V <sub>rms</sub>  V <sub>rms</sub>
		SPKBST = 0	(VCCSPK / 3.3) * 1.5			
Total harmonic distortion <sup>2</sup>	THD+N	P <sub>o</sub> = 200mW, VDDSPK = 3.3V		*63		dB
		P <sub>o</sub> = 320mW, VDDSPK = 3.3V		-64		dB
		P <sub>o</sub> = 500mW, VDDSPK = 5V		-60		dB
		P <sub>o</sub> = 860mW, VDDSPK = 5V		<b>-61</b>		dB
Signal-to-noise ratio	SNR	VDDSPK = 3.3V		91		dB
		VDDSPK = 5V		90		dB
Power supply rejection ratio (50Hz - 22kHz)	PSRR			81		dB
		VDDSPK = 5V (boost)		72		dB
<b>Analog Outputs (RHP / LHP; RSPKOUT / LSPKOUT)</b>						
Maximum programmable gain				+6		dB
Minimum programmable gain				-57		dB
Programmable gain step size		Guaranteed monotonic		1		dB
Mute attenuation		1kHz full scale signal		<b>85</b>		dB

## Electrical Characteristics, cont'd.

Conditions: VDDC = 1.8V, VDDA = VDDDB = VCCSPK = 3.3V, MCLK = 12.288MHz,  
T<sub>A</sub> = +25°C, 1kHz signal, fs = 48kHz, 24-bit audio data, unless otherwise stated.

Parameter	Symbol	Comments/Conditions	Min	Typ	Max	Units
<b>Headphone Output (RHP / LHP with 32Ω load)</b>						
0dB full scale output voltage				AVDD / 3.3		V <sub>rms</sub>
Signal-to-noise ratio	SNR	A-weighted		92		dB
Total harmonic distortion <sup>2</sup>	THD+N	R <sub>L</sub> = 16Ω, P <sub>o</sub> = 20mW, VDDA = 3.3V		80		dB
		R <sub>L</sub> = 32Ω, P <sub>o</sub> = 20mW, VDDA = 3.3V		85		dB
<b>AUXOUT1 / AUXOUT2 with 10kΩ / 50pF load</b>						
Full scale output		AUX1BST = 0 AUX2BST = 0		VDDSPK / 3.3		V <sub>rms</sub>
		AUX1BST = 1 AUX2BST = 1		(VDDSPK / 3.3) * 1.5		V <sub>rms</sub>
Signal-to-noise ratio	SNR			87		dB
Total harmonic distortion <sup>2</sup>	THD+N			-83		dB
Channel separation		1kHz signal		99		dB
Power supply rejection ratio (50Hz - 22kHz)	PSRR			53		dB
		VDDSPK = 5V (boost)		56		dB
<b>Microphone Inputs (LMICP, LMICN, RMICP, RMICN, LLIN, RLIN) and Programmable Gain Amplifier (PGA)</b>						
Full scale input signal <sup>1</sup>		PGABST = 0dB PGAGAIN = 0dB		1.0 0		V <sub>rms</sub> dBV
			-12		35.25	dB
Programmable gain				0.75		dB
Programmable gain step size		Guaranteed Monotonic		120		dB
Mute Attenuation						dB
Input resistance		Inverting Input PGA Gain = 35.25dB PGA Gain = 0dB PGA Gain = -12dB <b>Non-inverting Input</b>		1.6		kΩ
				47		kΩ
				75		kΩ
				94		kΩ
Input capacitance				10		pF
PGA equivalent input noise		0 to 20kHz, Gain set to 35.25dB		120		μV
<b>Input Boost Mixer</b>						
Gain boost		Boost disabled		0		dB
		Boost enabled		20		dB
Gain range LLIN / RLIN or LAUXIN / RAUXIN to boost/mixer			-12		6	dB
Gain step size to boost/mixer				3		dB
<b>Auxiliary Analog Inputs (LAUXIN, RAUXIN)</b>						
Full scale input signal <sup>1</sup>		Gain = 0dB		1.0 0		V <sub>rms</sub> dBV
					20 40 159	
Input resistance		Aux direct-to-out path, only Input gain = +6.0dB Input gain = 0.0dB Input gain = -12dB		10		pF

### Electrical Characteristics, cont'd.

Conditions: VDDC = 1.8V, VDDA = VDDDB = VCCSPK = 3.3V, MCLK = 12.88MHz,  
T<sub>A</sub> = +25°C, 1kHz signal, fs = 48kHz, 24-bit audio data, unless otherwise stated.

Parameter	Symbol	Comments/Conditions	Min	Typ	Max	Units
<b>Automatic Level Control (ALC) &amp; Limiter: ADC path only</b>						
Target record level			-22.5		-1.5	dBFS
Programmable gain			-12		35.25	dB
Gain hold time <sup>3</sup>	t <sub>HOLD</sub>	Doubles every gain step, with 16 steps total	0 / 2.67 / 5.33 / ... / 43691			ms
Gain ramp-up (decay) <sup>3</sup>	t <sub>DCY</sub>	ALC Mode ALC = 0	4 / 8 / 16 / ... / 4096			ms
		Limiter Mode ALC = 1	1 / 2 / 4 / ... / 1024			ms
Gain ramp-down (attack) <sup>3</sup>	t <sub>ATK</sub>	ALC Mode ALC = 0	1 / 2 / 4 / ... / 1024			ms
		Limiter Mode ALC = 1	0.25 / 0.5 / 1 / ... / 128			ms
Mute Attenuation				120		dB
<b>Microphone Bias</b>						
Bias voltage	V <sub>MICBIAS</sub>	See Figure 3	0.50, 0.60, 0.65, 0.70, 0.75, 0.85, or 0.90			VDDA VDDA
Bias current source	I <sub>MICBIAS</sub>			3		mA
Output noise voltage	V <sub>n</sub>	1kHz to 20kHz		14		nV/√Hz
<b>Digital Input/Output</b>						
Input HIGH level	V <sub>IL</sub>		0.7 * VDDC			V
Input LOW level	V <sub>IH</sub>				0.3 * VDDC	V
Output HIGH level	V <sub>OH</sub>	I <sub>Load</sub> = 1mA	0.9 * VDDC			V
Output LOW level	V <sub>OL</sub>	I <sub>Load</sub> = -1mA			0.1 * VDDC	V
Input capacitance				10		pF

#### Notes

1. Full Scale is relative to the magnitude of VDDA and can be calculated as FS = VDDA/3.3.
2. Distortion is measured in the standard way as the combined quantity of distortion products plus noise. The signal level for distortion measurements is at 3dB below full scale, unless otherwise noted.
3. Time values scale proportionally with MCLK. Complete descriptions and definitions for these values are contained in the detailed descriptions of the ALC functionality.
4. With default register settings, SPKVDD should be 1.5xVDDA (but not exceeding maximum recommended operating voltage) to optimize available dynamic range in the AUXOUT1, AUXOU2, RSPKOUT, and LSPKOUT outputs stages.



## Absolute Maximum Ratings

Condition	Min	Max	Units
VDDDB, VDDC, VDDA supply voltages	-0.3	+3.90	V
VDDSPK supply voltage (default register configuration)	-0.3	+5.80	V
VDDSPK supply voltage (optional low voltage configuration)	-0.3	+3.90	V
Core Digital Input Voltage range	VSSD – 0.3	VDDC + 0.30	V
Buffer Digital Input Voltage range	VSSD – 0.3	VDDDB + 0.30	V
Analog Input Voltage range	VSSA – 0.3	VDDA + 0.30	V
Industrial operating temperature	-40	+85	°C
Storage temperature range	-65	+150	°C

*CAUTION: Do not operate at or near the maximum ratings listed for extended periods of time. Exposure to such conditions may adversely influence product reliability and result in failures not covered by warranty.*

## Operating Conditions

Condition	Symbol	Min	Typical	Max	Units
Digital supply range (Core)	VDDC	1.65		3.60	V
Digital supply range (Buffer)	VDDDB	1.65		3.60	V
Analog supply range	VDDA	2.50		3.60	V
Speaker supply (SPKBST=0)	VDDSPK	2.50		5.50	V
Speaker supply (SPKBST=1)	VDDSPK	2.50		5.50	V
Ground	VSSD VSSA VSSSPK		0		V

1. VDDA must be  $\geq$  VDDC.
2. VDDDB must be  $\geq$  VDDC.

## 1 General Description

The WAU8822 is a stereo device with identical left and right channels that share common support elements. Additionally, the right channel auxiliary output path includes a dedicated submixer that supports mixing the right auxiliary input directly into the right speaker output driver. This enables the right speaker channel to output audio that is not present on any other output.

### 1.1.1 Analog Inputs

All inputs, except for the wide range programmable amplifier (PGA), have available analog input gain conditioning of -15dB through +6dB in 3dB steps. All inputs also have individual muting functions with excellent channel isolation and off-isolation from all outputs. All inputs are suitable for full quality, high bandwidth signals.

Each of the left-right stereo channels includes a low noise differential PGA amplifier, programmable for high-gain input. This may be used for a microphone level through line level source. Gain may be set from +35.25dB through -12dB at the analog difference-amplifier type programmable amplifier input stage. A separate additional 20dB analog gain is available on this input path, between the PGA output and ADC mixer input. The output of the ADC mixer may be routed to the ADC and/or analog bypass to the analog output sections.

Each channel also has a line level input. This input may be routed to the input PGA, and/or directly to the ADC input mixer.

Each channel has a separate additional auxiliary input. This is a line level input which may be routed the ADC input mixer and/or directly to the analog output mixers.

### 1.1.2 Analog Outputs

There are six high current analog audio outputs. These are very flexible outputs that can be used individually or in stereo pairs for a wide range of end uses. However, these outputs are optimized for specific functions and are described in this section using the functional names that are applicable to those optimized functions.

Each output receives its signal source from built-in analog output mixers. These mixers enable a wide range of signal combinations, including muting of all sources. Additionally, each output has a programmable gain function, output mute function, and output disable function.

The RHP and LHP headphone outputs are optimized for driving a stereo pair of headphones, and are powered from the main analog voltage supply rail, VDDA. These outputs may be coupled using traditional DC blocking series capacitors. Alternatively, these may be configured in a no-capacitor DC coupled design using a virtual ground at  $\frac{1}{2}$  VDDA provided by an AUXOUT analog output.

The AUXOUT1 and AUXOUT2 analog outputs are powered from the VDDSPK supply rail and VSSSPK ground return path. The supply rail may be the same as VDDA, or may be a separate voltage up to 5.5Vdc. This higher voltage enables these outputs to have an increased output voltage range and greater output power capability.

The RSPKOUT and LSPKOUT loudspeaker outputs are powered from the VDDSPK power supply rail and VSSGND ground return path. LSPKOUT receives its audio signal via an additional submixer. This submixer supports combining a traditional alert sound (from the RAUXIN input) with the right channel headphone output mixer signal. This submixer also provides the signal invert function that is necessary for the normal BTL (Bridge Tied Load) configuration used to drive a high power external loudspeaker. Alternatively, each loudspeaker output may be used individually as a separate high current analog output driver.

### 1.1.3 ADC, DAC, and Digital Signal Processing

Each left and right channel has an independent high quality ADC and DAC associated with it. These are high performance, 24-bit delta-sigma converters that are suitable for a very wide range of applications.

The ADC and DAC functions are each individually supported by powerful analog mixing and routing. The ADC output may be routed to the digital output path and/or to the input of the DAC in a digital passthrough mode. The ADC and DAC blocks are also supported by advanced digital signal processing subsystems that enable a very wide range of programmable signal conditioning and signal optimizing functions. All digital processing is with 24-bit precision, as to minimize processing artifacts and maximize the audio dynamic range supported by the WAU8822.

The ADCs are supported by a wide range, mixed-mode Automatic Level Control (ALC), a high pass filter, and a notch filter. All of these features are optional and highly programmable. The high pass filter function is intended for DC-blocking or low frequency noise reduction, such as to reduce unwanted ambient noise or “wind noise” on a microphone input. The notch filter may be programmed to greatly reduce a specific frequency band or frequency, such as a 50Hz, 60Hz, or 217Hz unwanted noise.

The DACs are supported by a programmable limiter/DRC (Dynamic Range Compressor). This is useful to optimize the output level for various applications and for use with small loudspeakers. This is an optional feature that may be programmed to limit the maximum output level and/or boost an output level that is too small.

Digital signal processing is also provided for a 3D Audio Enhancement function, and for a 5-Band Equalizer. These features are optional, and are programmable over wide ranges. This pair of digital processing features may be applied jointly to either the ADC audio path or to the DAC audio path, but not to both paths simultaneously.

### 1.1.4 Voltage Reference and Microphone Bias

Built-in power management includes a high stability voltage reference. This is used as an internal reference, and to generate a high quality, programmable microphone bias supply voltage that is well isolated from the supply rails. This microphone bias supply is suitable for both conventional electret (ECM) type microphone, and to power the newer MEMS all-silicon type microphones.

### 1.1.5 Digital Interfaces

Command and control of the device is accomplished using a 2-wire/3-wire/4-wire serial control interface. This is a simple, but highly flexible interface that is compatible with many commonly used command and control serial data protocols and host drivers.

Digital audio input/output data streams are transferred to and from the device separately from command and control. The digital audio data interface supports either I2S or PCM audio data protocols, and is compatible with commonly used industry standard devices that follow either of these two serial data formats.

### 1.1.6 Clock Requirements

The clocking signals required for the audio signal processing, audio data I/O, and control logic may be provided externally, or by optional operation of a built-in PLL (Phase Locked Loop). An external master clock (MCLK) signal must be active for analog audio logic paths to align with control register updates, and is required as the reference clock input for the PLL, if the PLL is used.

The PLL is provided as a low cost, zero external component count optional method to generate required clocks in almost any system. The PLL is a fractional-N divider type design, which enables generating accurate desired audio sample rates derived from a very wide range of commonly available system clocks.

The frequency of the system clock provided as the PLL reference frequency may be any stable frequency in the range between 8MHz and 33MHz. Because the fractional-N multiplication factor is a very high precision 24-bit value, any desired sample rate supported by the WAU8822 can be generated with very high accuracy, typically limited by the accuracy of the external reference frequency. Reference clocks and sample rates outside of these ranges are also possible, but may involve performance tradeoffs and increased design verification.

## 2 Application Information

### 2.1 Typical Application Schematic

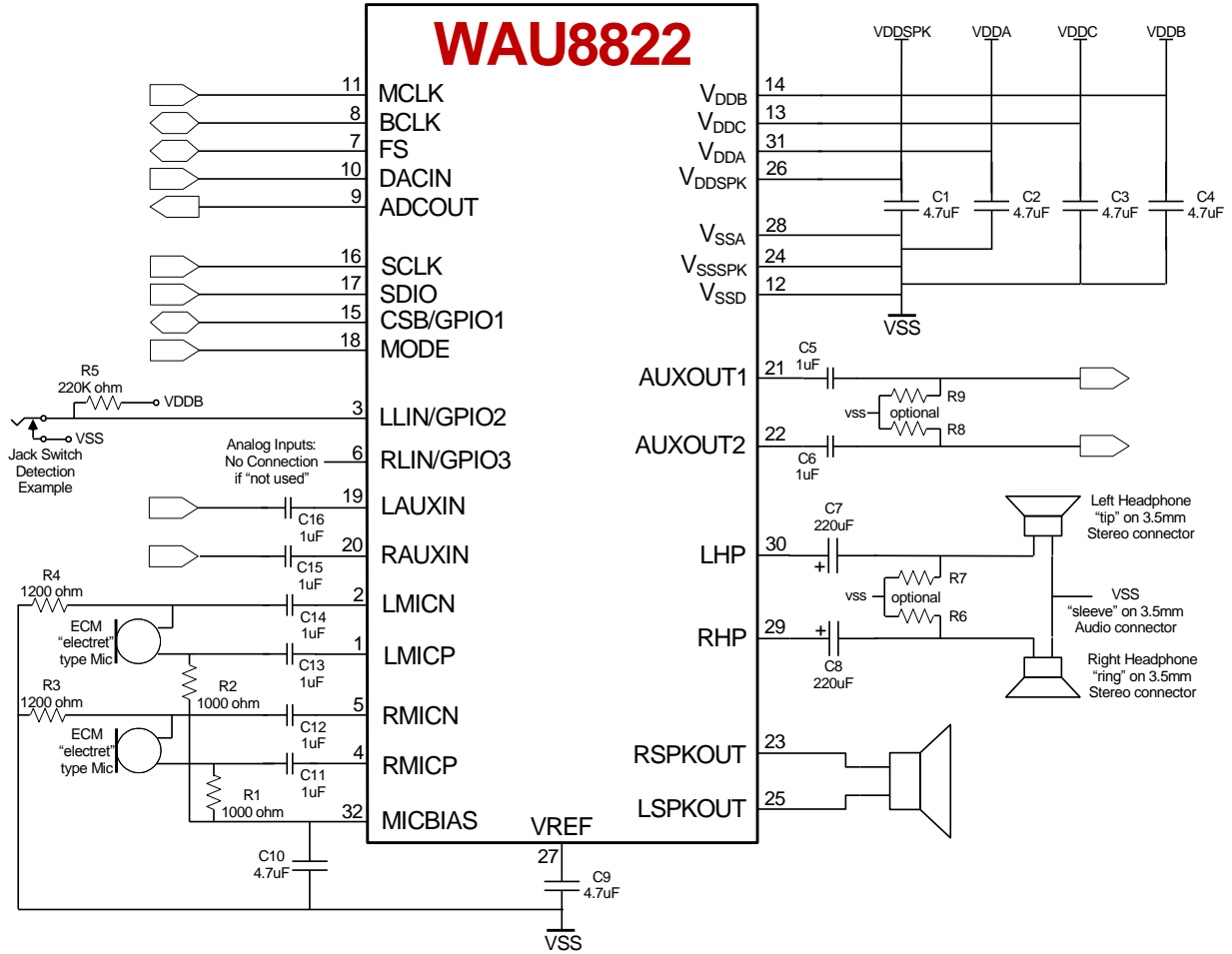

Figure 2: Schematic with recommended external components for typical application with AC-coupled headphones and stereo electret (ECM) style microphones.

- Note 1: All non-polar capacitors are assumed to be low ESR type parts, such as with MLC construction or similar. If capacitors are not low ESR, additional 0.1uF and/or 0.01uF capacitors may be necessary in parallel with the bulk 4.7uF capacitors on the supply rails.
- Note 2: Load resistors to ground on outputs may be helpful in some applications to insure a DC path for the output capacitors to charge/discharge to the desired levels. If the output load is always present and the output load provides a suitable DC path to ground, then the additional load resistors may not be necessary. If needed, such load resistors are typically a high value, but a value dependent upon the application requirements.
- Note 3: To minimize pops and clicks, large polarized output capacitors should be a low leakage type.
- Note 4: Depending on the microphone device and PGA gain settings, common mode rejection can be improved by choosing the resistors on each node of the microphone such that the impedance presented to any noise on either microphone wire is equal.

## 2.2 Power Consumption

WAU8822 has flexible power management capability which allows sections not being used to be powered down, to draw minimum current in battery-powered applications. Table – shows typical power consumption in different operating conditions.

Mode	Conditions	VDDA = 3V	VDDC = 1.8V	VDDB = 3V	Total Power mW
		mA	mA	mA	
OFF		tbd	tbd	tbd	tbd
Sleep	VREF off, no clocks,	0.1	0.001	0.0003	0.15
	VREF maintained @ 75kΩ, no clocks,	0.0	0.001	0.0003	0.045
	VREF maintained @ 300kΩ, no clocks,	0.0	0.001	0.0003	0.025
	VREF maintained @ 5kΩ, no clocks,	0.3	0.001	0.0003	0.78
Stereo Record	8kHz	7.9	1.7	0.005	26.7
	8kHz, PLL on	10.4	2.9	0.07	36.6
Stereo Playback	16Ω HP, 44.1kHz, PLL on, sine wave	24.5	8.2	0.07	88.5
	16Ω HP, 44.1kHz, quiescent	4.4	6.2	0.005	24.4
	16Ω HP, 44.1kHz, white noise	7.2	6.5	0.005	33.3
	16Ω HP, 44.1kHz, sine wave	22.0	6.8	0.005	78.3
	16Ω HP, 44.1kHz, PLL on, sine wave	24.5	8.2	0.07	88.5

Table 1: Typical Power Consumption in Various Application Modes.

### 2.3 Supply Currents of Specific Blocks

WAU8822 can be programmed to enable/disable various analog blocks individually, and the current to some of the major blocks can be reduced with minimum impact on performance. The table below shows the change in current consumed with different register settings. Sample rate settings will vary current consumption of VDDC supply, which draws consumes approximately 4mA @ 1.8V and fs = 48kHz. Lower sampling rates draw lower current.

Register		Function	Bit	VDDA current increase/ Decrease when enabled
Dec	Hex			
1	01	Power Management 1	REFIMP[1:0]	+100 $\mu$ A for 80k $\Omega$ and 300k $\Omega$ +260 $\mu$ A for 3k $\Omega$
			IOBUFEN[2]	+100 $\mu$ A
			ABIASEN[3]	+600 $\mu$ A
			MICBIASEN[4]	+540 $\mu$ A
			PLLEN[5]	+2.5 mA +1/5mA from VDDC with clocks applied
			AUX2MXEN[6]	+200 $\mu$ A
			AUX1MXEN[7]	+200 $\mu$ A
			DCBUFEN[8]	+140 $\mu$ A
2	02	Power Management 2	LADCEN[0]	+2.3 mA with 64X OSR +3.3 mA with 128X OSR
			RADCEN[1]	+2.3 mA with 64X OSR +3.3 mA with 128X OSR
			LPGAEN[2]	+300 $\mu$ A
			RPGAEN[3]	+300 $\mu$ A
			LBSTEN[4]	+650 $\mu$ A
			RBSTEN[5]	+650 $\mu$ A
			SLEEP[6]	
			LHPEN[7]	+800 $\mu$ A
RHPEN[8]	+800 $\mu$ A			
3	03	Power Management 3	LDACEN[0]	+1.6 mA with 64X OSR +1.7 mA with 128X OSR
			RDACEN[1]	+1.6 mA with 64X OSR +1.7 mA with 128X OSR
			LMIXEN[2]	+250 $\mu$ A
			RMIXEN[3]	+250 $\mu$ A
			BIASGEN[4]	
			RSPKEN[5]	+1.1 mA from VDDSPK
			LSPKEN[6]	+1.1 mA from VDDSPK
			AUXOUT2EN[7] AUXOUT1EN[8]	+225 $\mu$ A +225 $\mu$ A
58	3A	Power Management 4	IBIADJ[1:0]	-1.2mA with IBIADJ at 11
			REGVOLT[2:3]	
			MICBIASM[4]	
			LPSPKD[5]	
			LPADC[6]	-1.1mA with no SNR decrease @ 8kHz
			LPIPBST[7]	-600 $\mu$ A with no SNR decrease @ 8kHz
			LPDAC[8]	-1.1mA with 1.4dB SNR decrease @ 44.1kHz

Table 2: VDDA 3.3V Supply Current in Various Modes

### 3 Appendix A: Digital Filter Characteristics

Parameter	Conditions	Min	Typ	Max	Units
<b>ADC Filter</b>					
Passband	+/- 0.015dB	0		0.454	fs
	-6dB		0.5		fs
Passband Ripple				+/-0.015	dB
Stopband		0.546			fs
Stopband Attenuation	$f > 0.546*fs$	-60			dB
Group Delay			28.25		1/fs
<b>ADC High Pass Filter</b>					
High Pass Filter Corner Frequency	-3dB		3.7		Hz
	-0.5dB		10.4		Hz
	-0.1dB		21.6		Hz
<b>DAC Filter</b>					
Passband	+/- 0.035dB	0		0.454	fs
	-6dB		0.5		fs
Passband Ripple				+/-0.035	dB
Stopband		0.546			fs
Stopband Attenuation	$f > 0.546*fs$	-55			dB
Group Delay			28		1/fs

Table 3: Digital Filter Characteristics

#### TERMINOLOGY

1. Stop Band Attenuation (dB) – the degree to which the frequency spectrum is attenuated (outside audio band)
2. Pass-band Ripple – any variation of the frequency response in the pass-band region
3. Note that this delay applies only to the filters and does not include other latencies, such as from the serial data interface

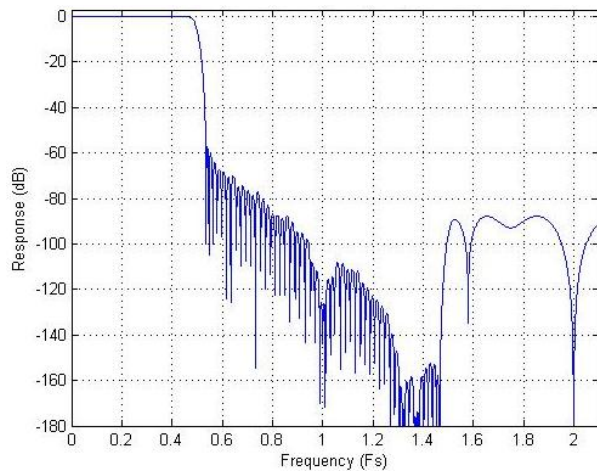

Figure 3: DAC Filter Frequency Response

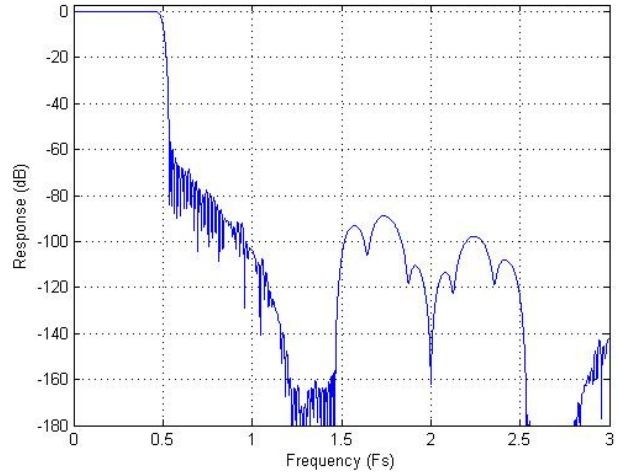

Figure 5: ADC Filter Frequency Response

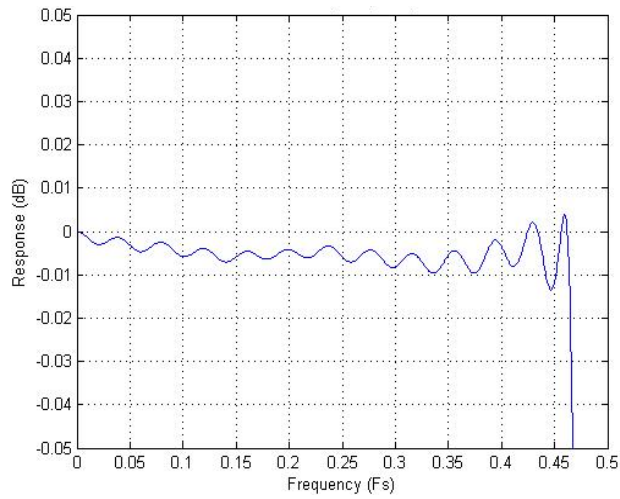

Figure 4: DAC Filter Ripple

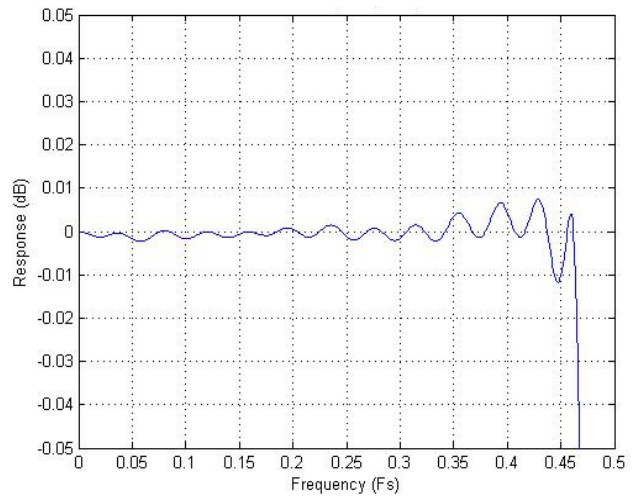

Figure 6: ADC Filter Ripple



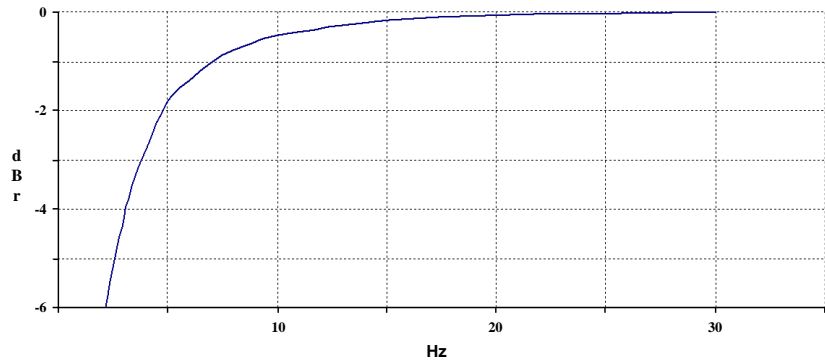

Figure 7: ADC Highpass Filter Response, Audio Mode

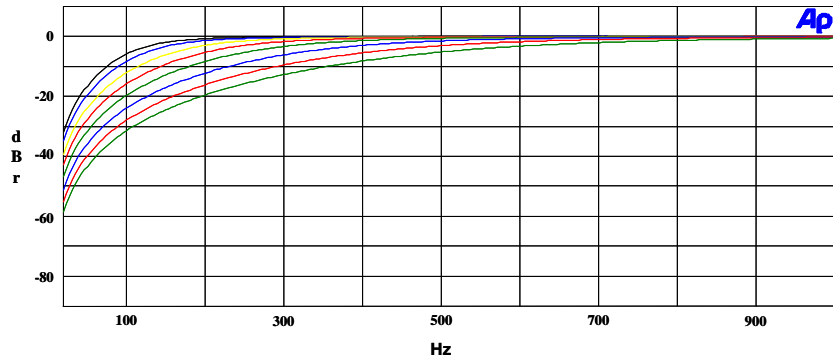

Figure 8: ADC Highpass Filter Response, HPF enabled, FS = 48kHz

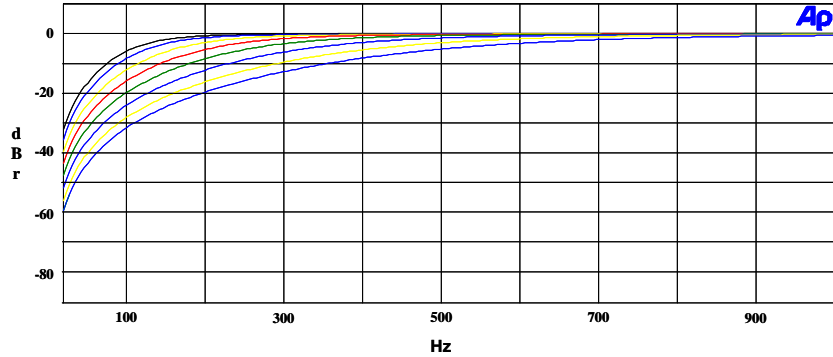

Figure 9: ADC Highpass Filter Response, HPF enabled, FS = 24kHz

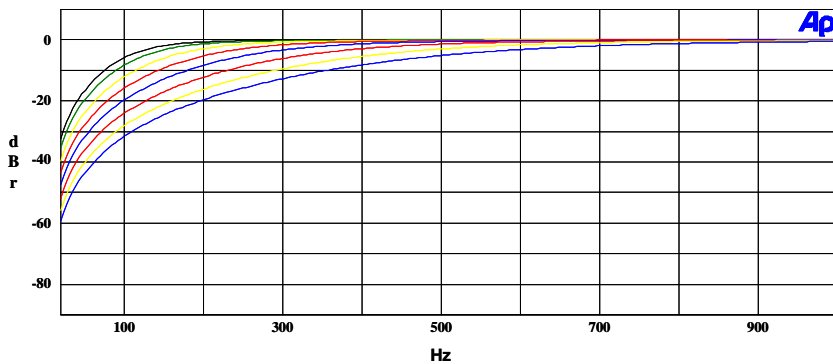

Figure 10: ADC Highpass Filter Response, HPF enabled, FS = 12kHz

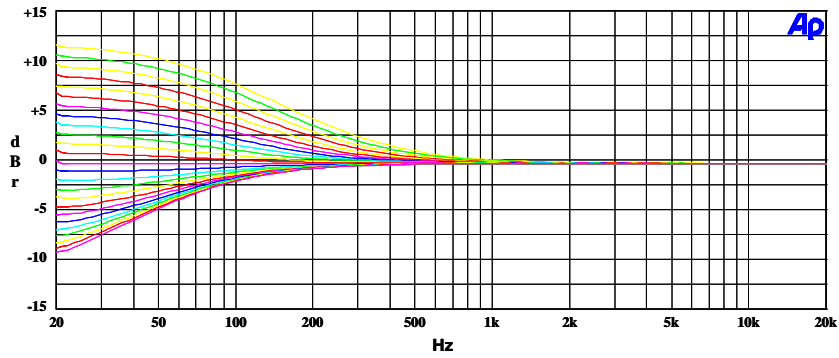

Figure 11: EQ Band 1 Gains for Lowest Cut-Off Frequency

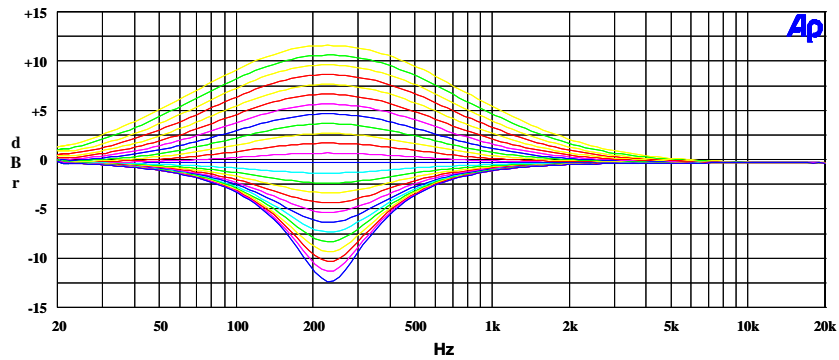

Figure 12: EQ Band 2 Peak Filter Gains for Lowest Cut-Off Frequency with EQ2BW = 0

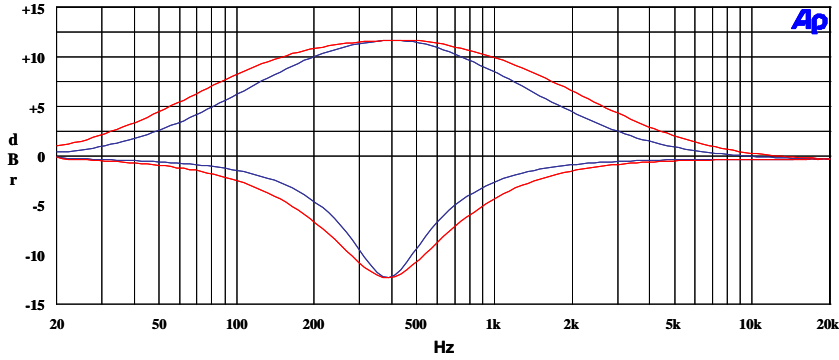

Figure 13: EQ Band 2, EQ2BW = 0 versus EQ2BW = 1

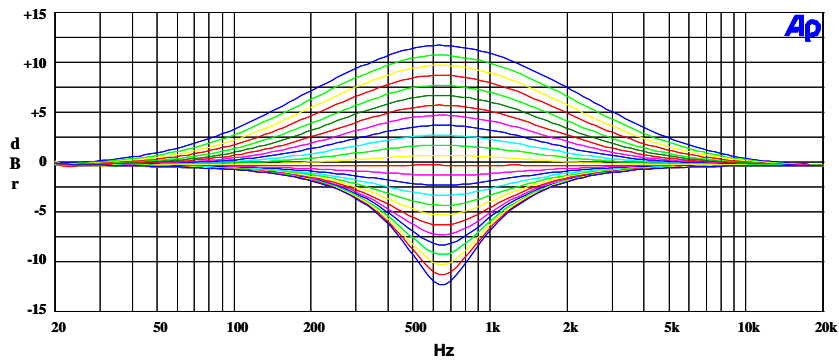

Figure 14: EQ Band 3 Peak Filter Gains for Lowest Cut-Off Frequency with EQ3BW = 0

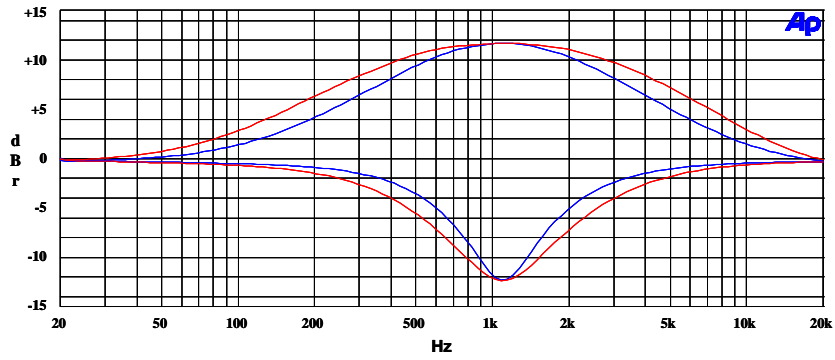

Figure 15: EQ Band 3, EQ3BW = 0 versus EQ3BW = 1

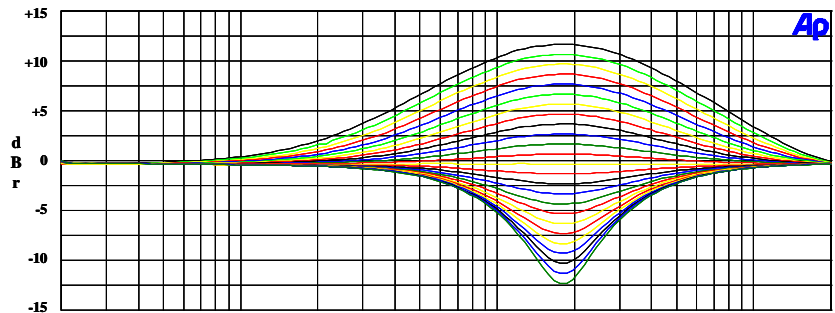

Figure 16: EQ Band 4 Peak Filter Gains for Lowest Cut-Off Frequencies with EQ4BW = 0

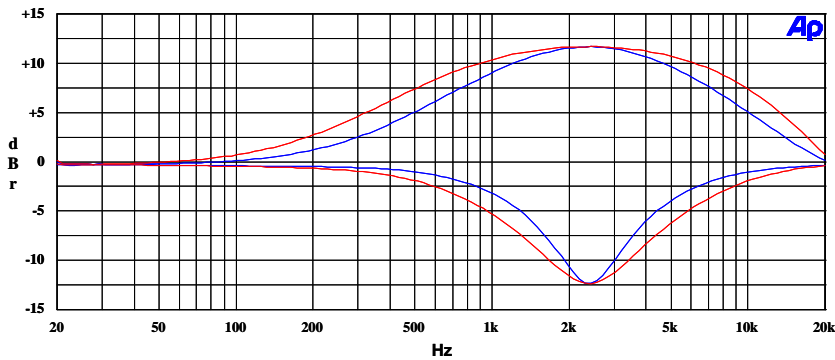

Figure 17: EQ Band 4, EQ4BW = 0 versus EQ4BW = 1

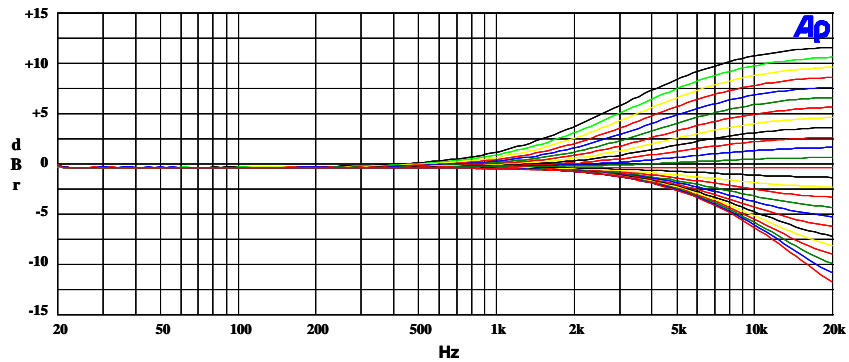

Figure 18: EQ Band 5 Gains for Lowest Cut-Off Frequency

## 4 Appendix D: Register Overview

DEC	HEX	NAME	Bit 8	Bit 7	Bit 6	Bit 5	Bit 4	Bit 3	Bit 2	Bit 1	Bit 0	Default		
0	00	Software Reset	RESET (SOFTWARE)											
1	01	Power Management 1	DCBUFEN	AUX1MXEN	AUX2MXEN	PLEN	MICBIASEN	ABIASEN	IOBUFEN	REFIMP		000		
2	02	Power Management 2	RHPEN	NHPEN	SLEEP	RBSTEN	LBSTEN	RPGAEN	LPGAEN	RADCEN	LADCEN	000		
3	03	Power Management 3	AUXOUT1EN	AUXOUT2EN	LSPKEN	RSPKEN	BIASGEN	RMIXEN	LMIXEN	RDACEN	LDACEN	000		
<b>General Audio Controls</b>														
4	04	Audio Interface	BCLKP	LRP	WLEN		AIFMT		DACPHS	ADCPHS	MONO		050	
5	05	Companding	Reserved			CMB8	DACC		ADCCM		PASSTHRU		000	
6	06	Clock Control 1	CLKM	MCLKSEL			BCLKSEL		Reserved		CLKIOEN		140	
7	07	Clock Control 2	4WSPEN	Reserved			Reserved		SMPLR		SCLKEN		000	
8	08	GPIO	Reserved			GPIO1PLL		GPIO1PL		GPIO1SEL			000	
9	09	Jack Detect 1	JCKMIDEN		JCKDEN	JCKDIO		Reserved				000		
10	0A	DAC Control	Reserved			SOFTMT		Reserved		DACOS	AUTOMT	RDACPL	LDACPL	000
11	0B	Left DAC Volume	LDACVU	LDACGAIN								OFF		
12	0C	Right DAC Volume	RDACVU	RDACGAIN								OFF		
13	0D	Jack Detect 2	Reserved			JCKDOEN1		JCKDOEN0				000		
14	0E	ADC Control	HPFEN	HPFAM	HPF		ADCOS		Reserved	RADCPL	LADCPL		100	
15	F	Left ADC Volume	LADCVU	LADCGAIN								OFF		
16	10	Right ADC Volume	RADCVU	RADCGAIN								OFF		
17	11	Reserved												
<b>Equalizer</b>														
18	12	EQ1-low cutoff	EQM	Reserved		EQ1CF		EQ1GC		12C				
19	13	EQ2-peak 1	EQ2BW	Reserved		EQ2CF		EQ2GC		02C				
20	14	EQ3-peak 2	EQ3BW	Reserved		EQ3CF		EQ3GC		02C				
21	15	EQ4-peak3	EQ4BW	Reserved		EQ4CF		EQ4GC		02C				
22	16	EQ5-high cutoff	Reserved			EQ5CF		EQ5GC		02C				
23	17	Reserved												
<b>DAC Limiter</b>														
24	18	DAC Limiter 1	DACLIMEN	DACLIMDCY			DACLIMATK		032					
25	19	DAC Limiter 2	Reserved			DACLIMTHL		DACLIMBST				000		
26	1A	Reserved												
<b>Notch Filter</b>														
27	1B	Notch Filter 1	NFCU1	NFCEN	Reserved			NFCA0[13:7]		000				
28	1C	Notch Filter 2	NFCU2	Reserved		NFCA0[6:0]			000					
29	1D	Notch Filter 3	NFCU3	Reserved		NFCA1[13:7]			000					
30	1E	Notch Filter 4	NFCU4	Reserved		NFCA1[6:0]			000					
31	1F	Reserved												
<b>ALC and Noise Gate Control</b>														
32	20	ALC Control 1	ALCEN		Reserved		ALCMXGAIN		ALCMNGAIN				038	
33	21	ALC Control 2	Reserved		ALCHT			ALCSL				00B		
34	22	ALC Control 3	ALCM		ALCDCY			ALCATK				032		
35	23	Noise Gate	Reserved			ALCTBLSEL		ALCNEN	ALCNTH				010	
<b>Phase Locked Loop</b>														
36	24	PLL N	Reserved			PLLCLK		PLL				008		
37	25	PLL K 1	Reserved			PLLK[23:18]						00C		
38	26	PLL K 2	PLLK[17:9]										093	
39	27	PLL K 3	PLLK[8:0]										0E9	
40	28	Mic Bias Mode	Reserved									MICBIASM	000	
<b>Miscellaneous</b>														
41	29	3D control	Reserved						3DDEPTH				000	
42	2A	Reserved												
43	2B	Right Speaker Submix	Reserved			RMIXMUT	RSUBBYP	RAUXRSUBG		RAUXSMUT			000	
44	2C	Input Control	MICBIASV		RLINRPGA	RMICNRPGA	RMICPRPGA	Reserved	LLINLPGA	LMICNLPGA	LMICPLPGA		033	
45	2D	Left Input PGA Gain	LPGAU	LPGAZC	LPGAMT	LPGAGAIN						010		
46	2E	Right Input PGA Gain	RPGAU	RPGAZC	RPGAMT	RPGAGAIN						010		
47	2F	Left ADC Boost	LPGABST	Reserved		LPGABSTGAIN		Reserved		LAUXBSTGAIN			100	
48	30	Right ADC Boost	RPGABST	Reserved		RPGABSTGAIN		SPKSTAGE	RAUXBSTGAIN				100	
49	31	Output Control	Reserved		LDACRMX	RDACLMX	AUX1BST	AUX2BST	SPKBST	TSEN	AOUTIMP		002	
50	32	Left Mixer	LAUXMXGAIN			LAUXLMX		LBYPMXGAIN		LBYPMLX		LDACLMX	001	
51	33	Right Mixer	RAUXMXGAIN			RAUXRMX		RBYPMXGAIN		RBYPRMX		RDACRMX	001	
52	34	LHP Volume	LHPVU	LHPZC	LHPMUTE	LHPGAIN						039		
53	35	RHP Volume	RHPVU	RHPZC	RHPMUTE	RHPGAIN						039		
54	36	LSPKOUT Volume	LSPKVU	LSPKZC	LSPKMUTE	LSPKGAIN						039		
55	37	RSPKOUT Volume	RSPKVU	RSPKZC	RSPKMUTE	RSPKGAIN						039		
56	38	AUX2 Mixer	Reserved		AUXOUT2MT	Reserved		AUX1MIX-2	LADCAUX2	LMIXAUX2	LDACAUX2		001	
57	39	AUX1 Mixer	Reserved		AUXOUT1MT	AUX1HALF	LMIXAUX1	LDACAUX1	RADCAUX1	RMIXAUX1	RDACAUX1		001	
58	3A	Power Management 4	LPDAC	LPIPBST	LPADC	LPSPKD	MICBIASM	REGVOLT		IBADJ			000	
<b>PCM Time Slot and ADCOUT Impedance Option Control</b>														
59	3B	Left Time Slot	Reserved						LTSLOT[8:0]				000	
60	3C	Misc	PCMTSEN	TRI	PCM8BIT	PUDEN	PUDPE	PUDPS	Reserved	RTSLOT[9]	LTSLOT[9]		020	
61	3D	Right Time Slot	RTSLOT[8:0]										000	
<b>Silicon Revision and Device ID</b>														
62	3E	Device Revision #	Reserved			REV						xxx		
63	3F	Device ID	ID										xxx	

## 5 Package Dimensions

32-lead Plastic QFN; 5X5mm<sup>2</sup>, 1.0mm thickness, 0.5mm lead pitch

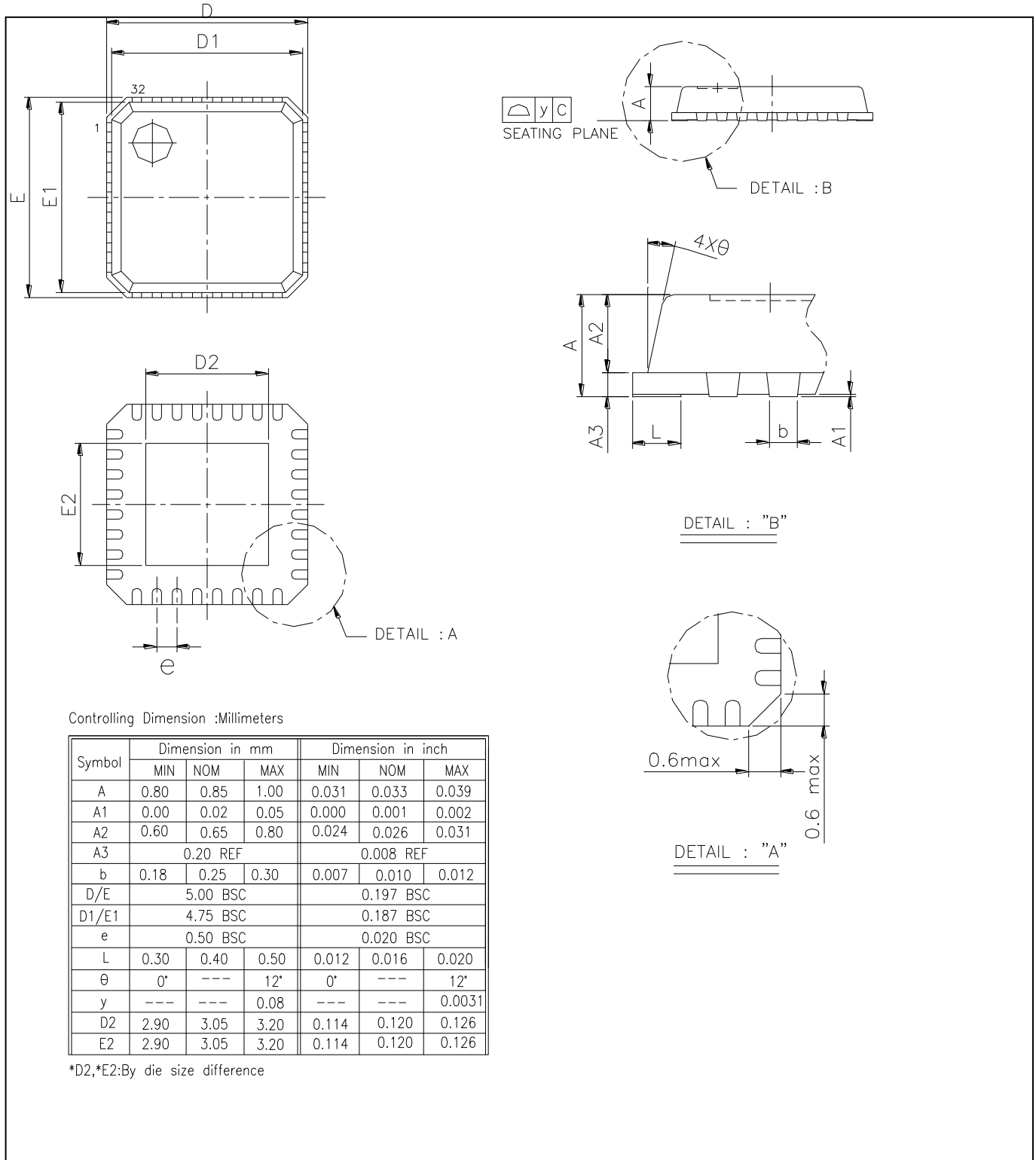

## 6 Ordering Information

Nuvoton Part Number Description

WAU8822YG

**Package Material:**

**G** = Pb-free Package

**Package Type:**

**Y** = 32-Pin QFN Package

### Version History

VERSION	DATE	PAGE	DESCRIPTION
A0.0	February, 2008	NA	Preliminary Revision
A0.6	May 2008	NA	Preliminary Revision
A0.86	September 2008	NA	Preliminary Revision

Table 4: Version History

### Important Notice

Nuvoton products are not designed, intended, authorized or warranted for use as components in systems or equipment intended for surgical implantation, atomic energy control instruments, airplane or spaceship instruments, transportation instruments, traffic signal instruments, combustion control instruments, or for other applications intended to support or sustain life. Furthermore, Nuvoton products are not intended for applications wherein failure of Nuvoton products could result or lead to a situation wherein personal injury, death or severe property or environmental damage could occur.

Nuvoton customers using or selling these products for use in such applications do so at their own risk and agree to fully indemnify Nuvoton for any damages resulting from such improper use or sales.

---

*Please note that all data and specifications are subject to change without notice.  
All the trademarks of products and companies mentioned in this datasheet belong to their respective owners.*